

- AREA FOR SOLAR PANELS AND ASSOCIATED DEVELOPMENT
- CABLE INFRASTRUCTURE
- SUBSTATION, BESS AND ASSOCIATED INFRASTRUCTURE
- BIODIVERSITY MITIGATION

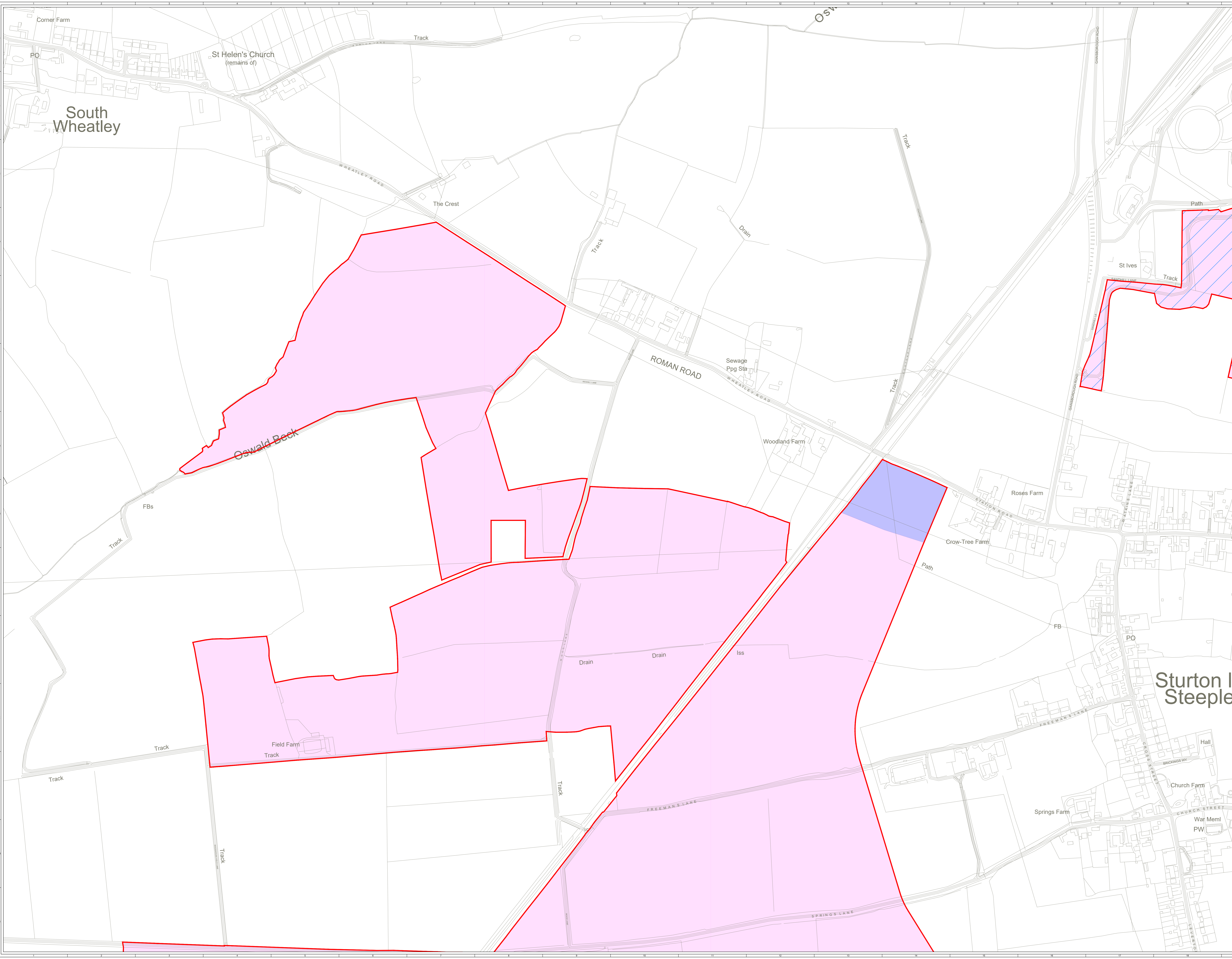

SITE LOCATION - NOT TO SCALE

SHEET 2 OF 8

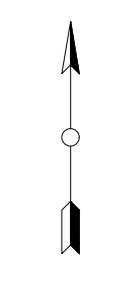

REV	DATE	BY	CHKD	APPD	DATE	REVISION NOTES
1	2024/06/18					

PURPOSE	PRELIMINARY	COORDINATES	OSGB 1936
SCALE	1:2,500 @ AD	DATUM	N/A
LAYOUT DWG	N/A	LAYOUT NO.	N/A
PROJECT TITLE	STEEPLE RENEWABLES PROJECT		
DRAWING TITLE	FIGURE 1.2 INDICATIVE PARAMETERS PLAN APFP REGULATION 5(2)(A)		
RES DRAWING NUMBER	04954-RES-LAY-DR-LE-018	REV	1



- AREA FOR SOLAR PANELS AND ASSOCIATED DEVELOPMENT
- CABLE INFRASTRUCTURE
- SUBSTATION, BESS AND ASSOCIATED INFRASTRUCTURE
- BIODIVERSITY MITIGATION

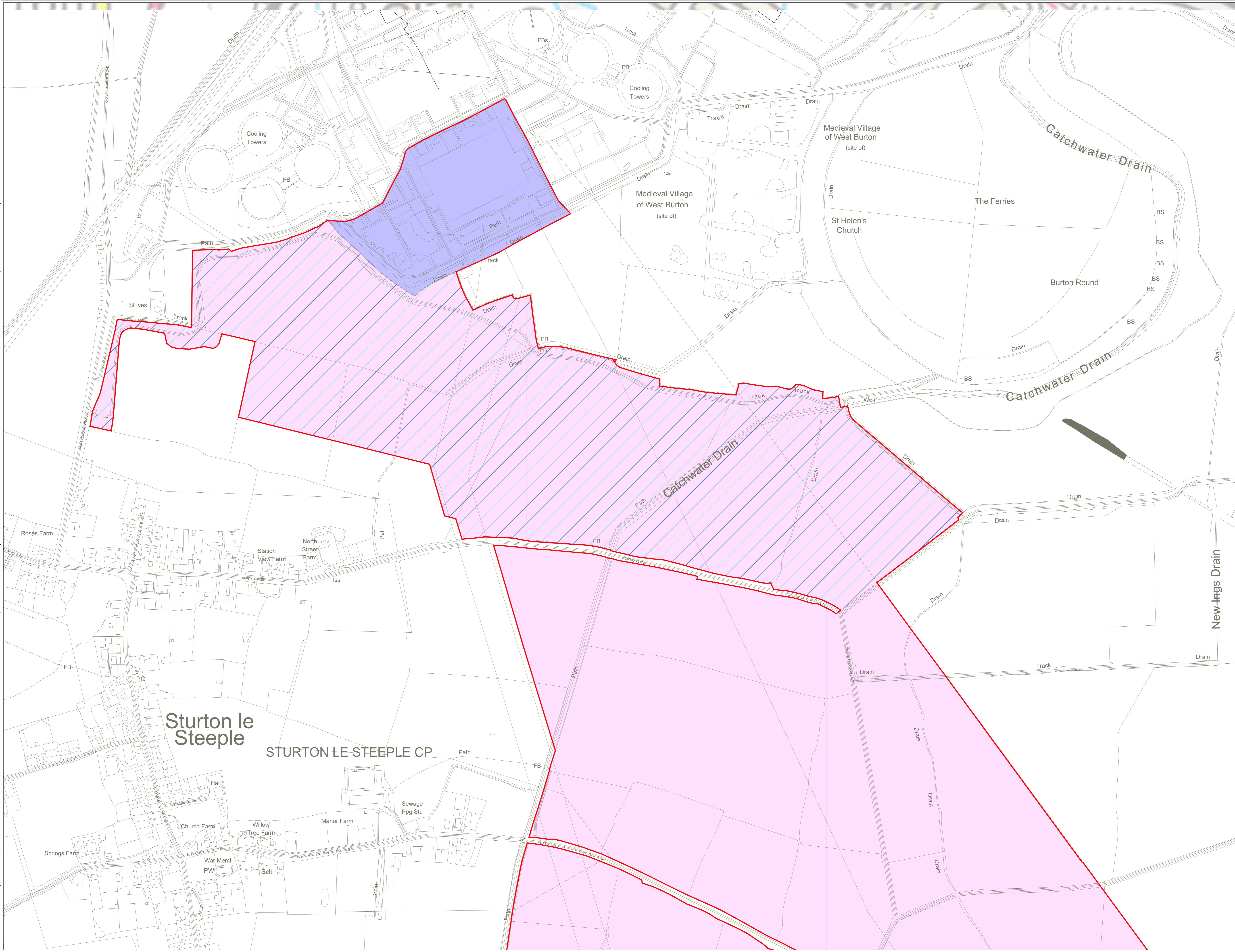

SITE LOCATION - NOT TO SCALE

SHEET 3 OF 8

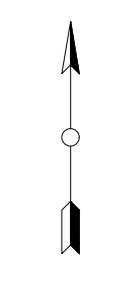

REV	DATE	BY	CHKD	APPD	DATE	REVISION NOTES
1	2024/06/18					

PURPOSE	PRELIMINARY	COORDINATES	OSGB 1936
SCALE	1:2,500	@ AD	N/A
LAYOUT DWG	N/A	LAYOUT NO.	N/A
PROJECT TITLE	STEEPLE RENEWABLES PROJECT		
DRAWING TITLE	FIGURE 1.2 INDICATIVE PARAMETERS PLAN APFP REGULATION 5(2)(A)		
RES DRAINING NUMBER	04954-RES-LAY-DR-LE-018		REV 1

THIS DRAWING IS THE PROPERTY OF RENEWABLE ENERGY CONSULTANTS AND NO REPRODUCTION MAY BE MADE IN WHOLE OR IN PART WITHOUT PERMISSION

BEAUFORT COURT,  
EGG FARM LANE,  
NORTH LAKELY,  
LEICESTERSHIRE, LE19 1JH,  
UK  
TEL: +44 (0) 150 280000  
WWW.RES-GROUP.COM



- AREA FOR SOLAR PANELS AND ASSOCIATED DEVELOPMENT
- CABLE INFRASTRUCTURE
- SUBSTATION, BESS AND ASSOCIATED INFRASTRUCTURE
- BIODIVERSITY MITIGATION

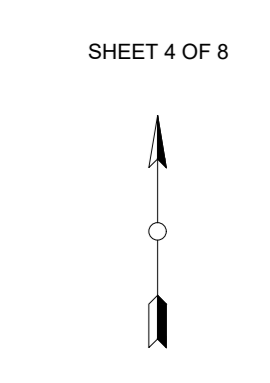

REV	NO	DATE	DESCRIPTION
1	1	2024/04/15	ISSUE FOR PERMITTING

PURPOSE	PRELIMINARY	COORDINATES	OSGB 1936
SCALE	1:2,500 @ A0	DATUM	N/A
LAYOUT DWG	N/A	LAYOUT NO.	N/A

PROJECT TITLE: STEEPLE RENEWABLES PROJECT

DRAWING TITLE: FIGURE 1.2 INDICATIVE PARAMETERS PLAN APPFP REGULATION 5(2)(A)

RES DRAWING NUMBER: 04954-RES-LAY-DR-LE-018

REV: 1



- AREA FOR SOLAR PANELS AND ASSOCIATED DEVELOPMENT
- CABLE INFRASTRUCTURE
- SUBSTATION, BESS AND ASSOCIATED INFRASTRUCTURE
- BIODIVERSITY MITIGATION

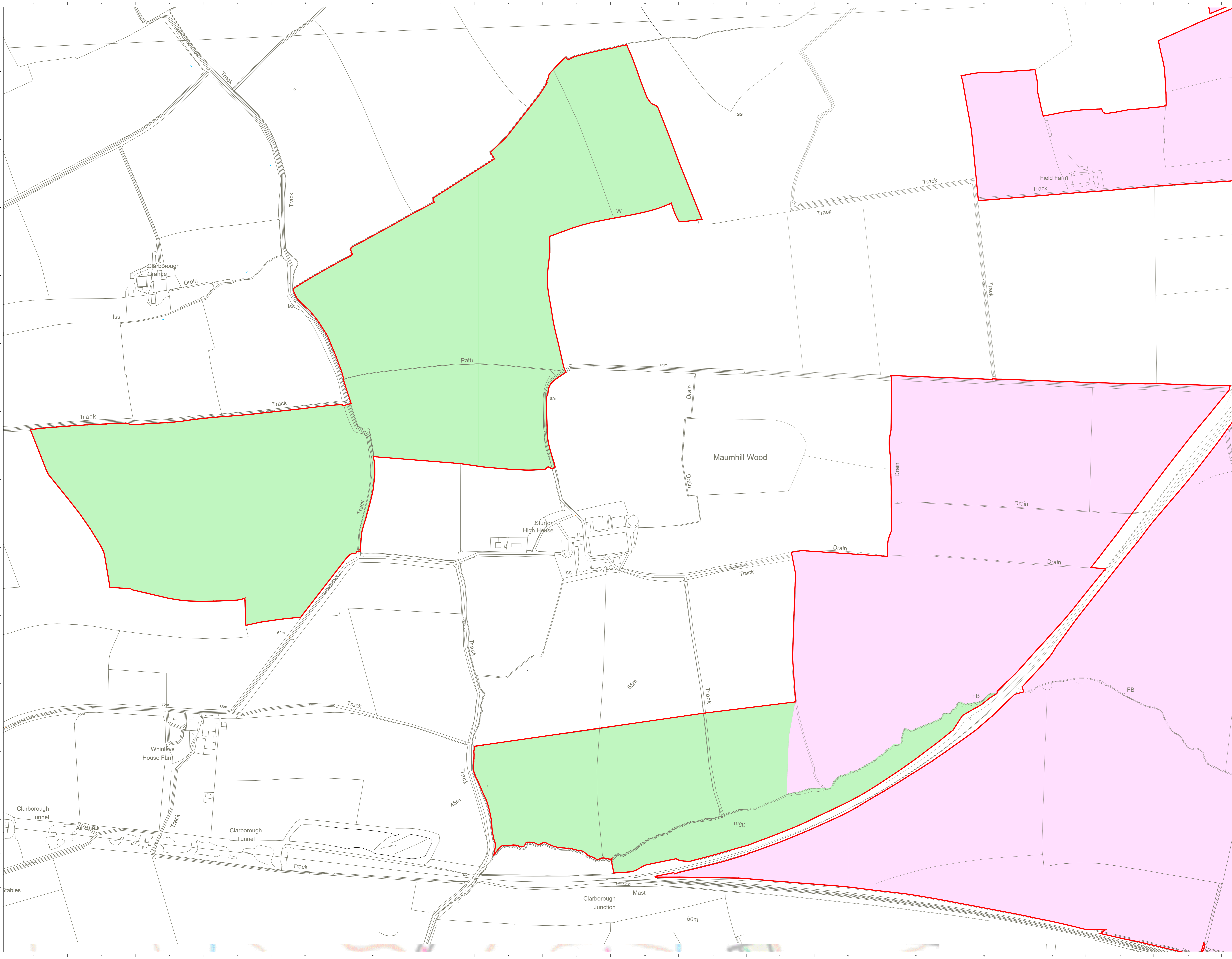

SITE LOCATION - NOT TO SCALE

SHEET 5 OF 8

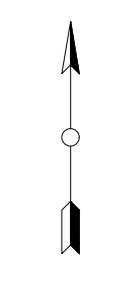

ISSUE	NO.	DATE	REVISIONS
PRELIMINARY			OSGB 1936

**FIGURE 1.2**  
**INDICATIVE PARAMETERS PLAN**  
APFP REGULATION 5(2)(A)

PROJECT TITLE: STEEPLE RENEWABLES PROJECT

DRAWING TITLE: FIGURE 1.2 INDICATIVE PARAMETERS PLAN

RES DRAWING NUMBER: 04954-RES-LAY-DR-LE-018

REV: 1

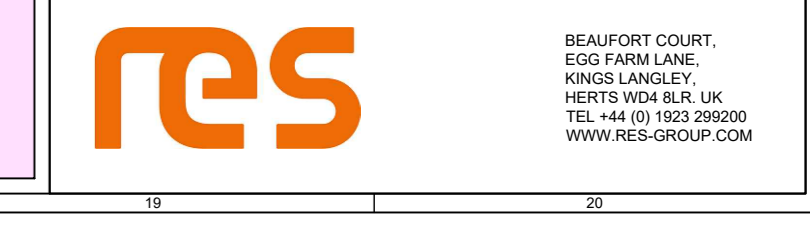



- AREA FOR SOLAR PANELS AND ASSOCIATED DEVELOPMENT
- CABLE INFRASTRUCTURE
- SUBSTATION, BESS AND ASSOCIATED INFRASTRUCTURE
- BIODIVERSITY MITIGATION

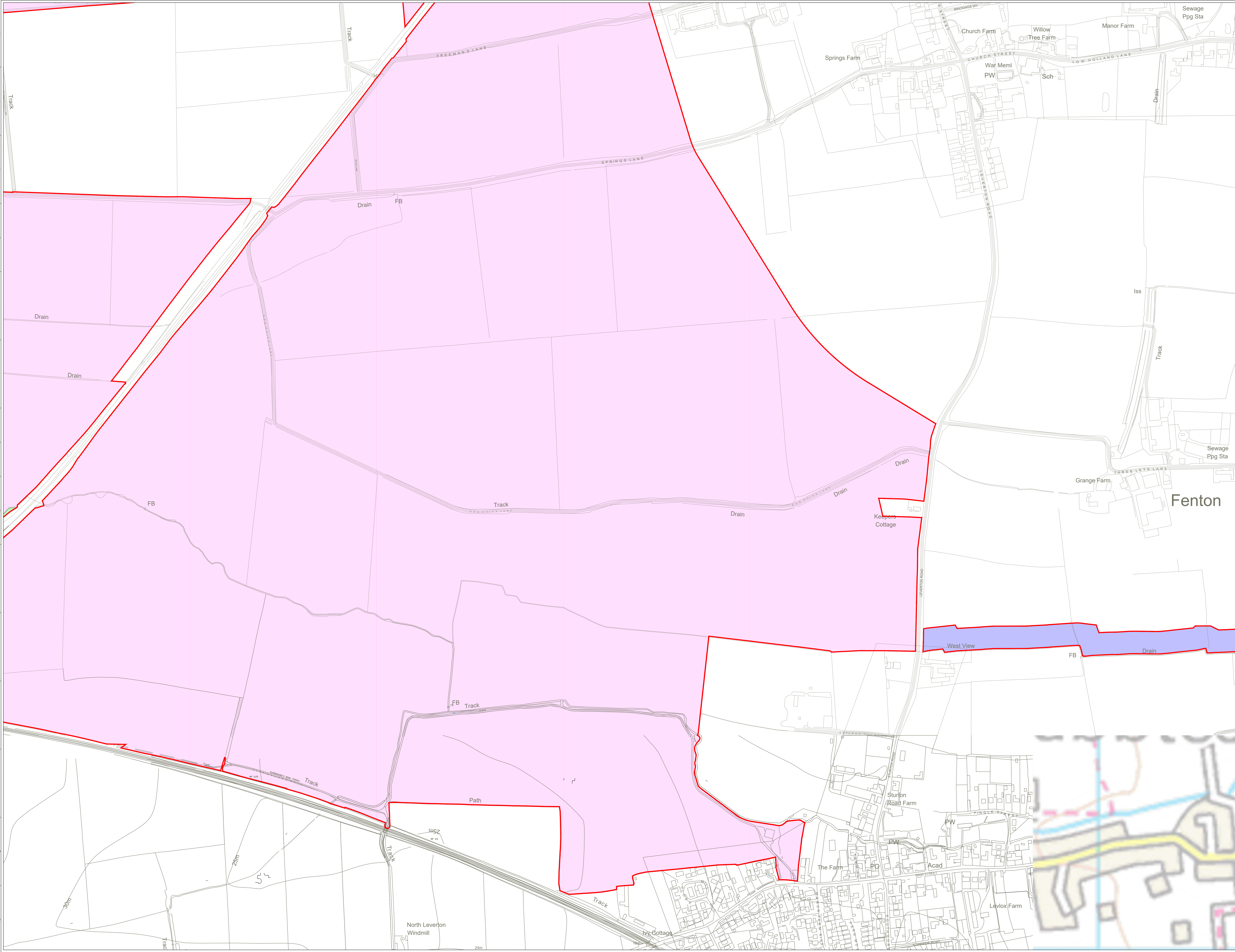

SITE LOCATION - NOT TO SCALE

SHEET 6 OF 6

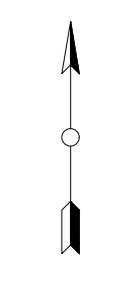

REV	NO	DATE	BY	CHKD	APPD	DATE	REVISION NOTES
1	1	2024/04/15					

PURPOSE	PRELIMINARY	COORDINATES	OSGB 1936
SCALE	1:2,500 @ A0	DATUM	N/A
LAYOUT DWG	N/A	LAYOUT NO.	N/A
PROJECT TITLE	STEEPLE RENEWABLES PROJECT		
DRAWING TITLE	FIGURE 1.2 INDICATIVE PARAMETERS PLAN APFP REGULATION 5(2)(A)		
RES DRAINING NUMBER	04954-RES-LAY-DR-LE-018		REV 1



- AREA FOR SOLAR PANELS AND ASSOCIATED DEVELOPMENT
- CABLE INFRASTRUCTURE
- SUBSTATION, BESS AND ASSOCIATED INFRASTRUCTURE
- BIODIVERSITY MITIGATION

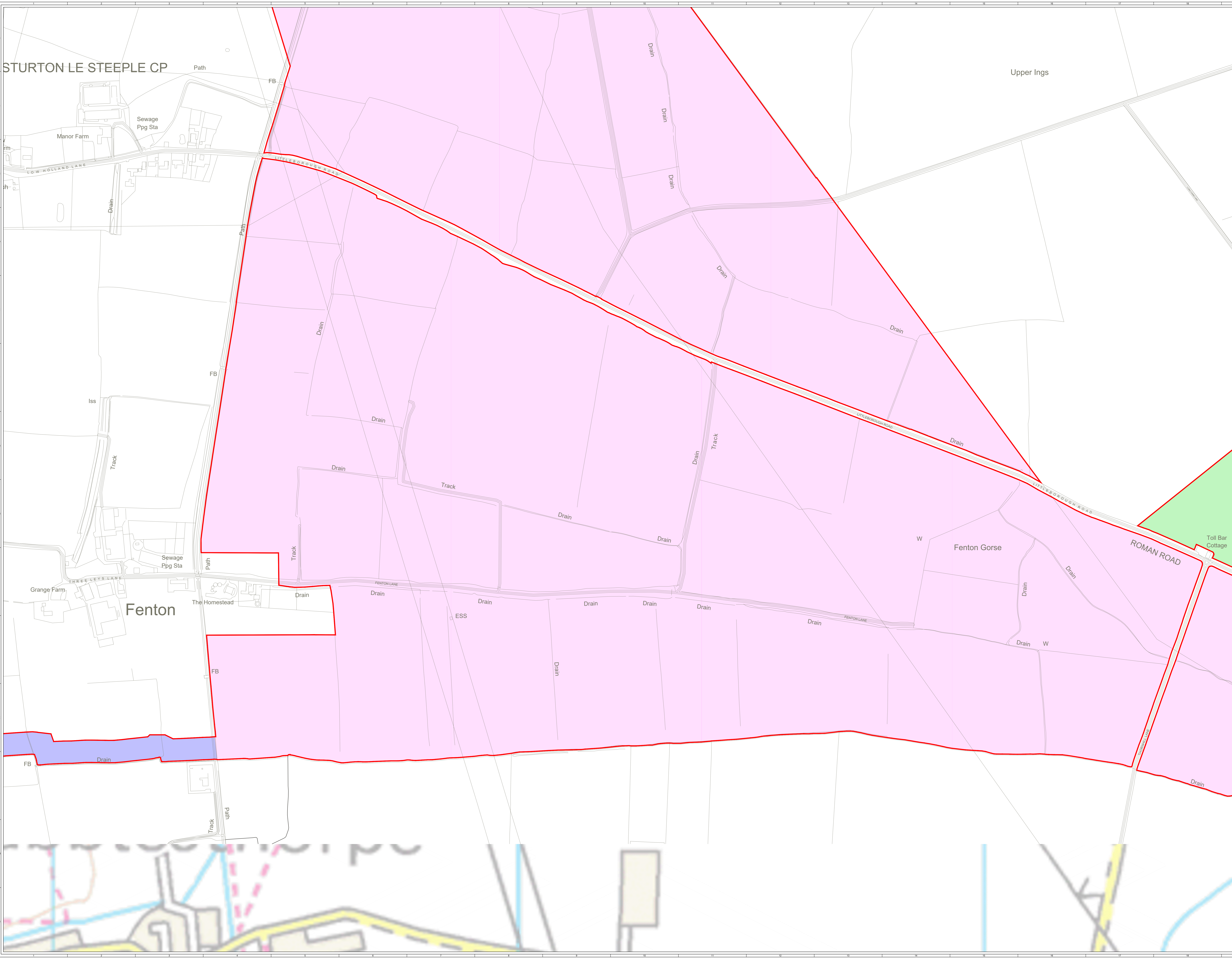

SITE LOCATION - NOT TO SCALE

SHEET 7 OF 8

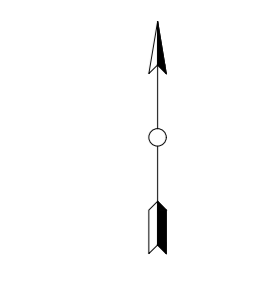

ISSUE NO	ISSUE DATE	ISSUE DESCRIPTION	ISSUE BY
1	2024/06/18	Final Issue	AD
PURPOSE		COORDINATES	OSGB 1936
SCALE	1:2,500	@ AD	N/A
LAYOUT DATE	N/A	LAYOUT NO.	N/A
PROJECT TITLE			
STEEPLE RENEWABLES PROJECT			

DRAWING TITLE  
**FIGURE 1.2**  
**INDICATIVE PARAMETERS PLAN**  
APFP REGULATION 5(2)(A)

RES DRAWING NUMBER  
**04954-RES-LAY-DR-LE-018**

REV 1

THIS DRAWING IS THE PROPERTY OF RES GROUP LIMITED AND NO REPRODUCTION MAY BE MADE IN WHOLE OR IN PART WITHOUT PERMISSION





- AREA FOR SOLAR PANELS AND ASSOCIATED DEVELOPMENT
- CABLE INFRASTRUCTURE
- SUBSTATION, BESS AND ASSOCIATED INFRASTRUCTURE
- BIODIVERSITY MITIGATION

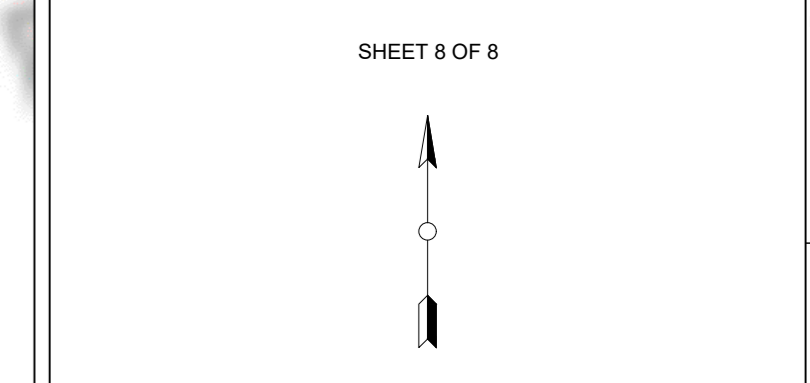
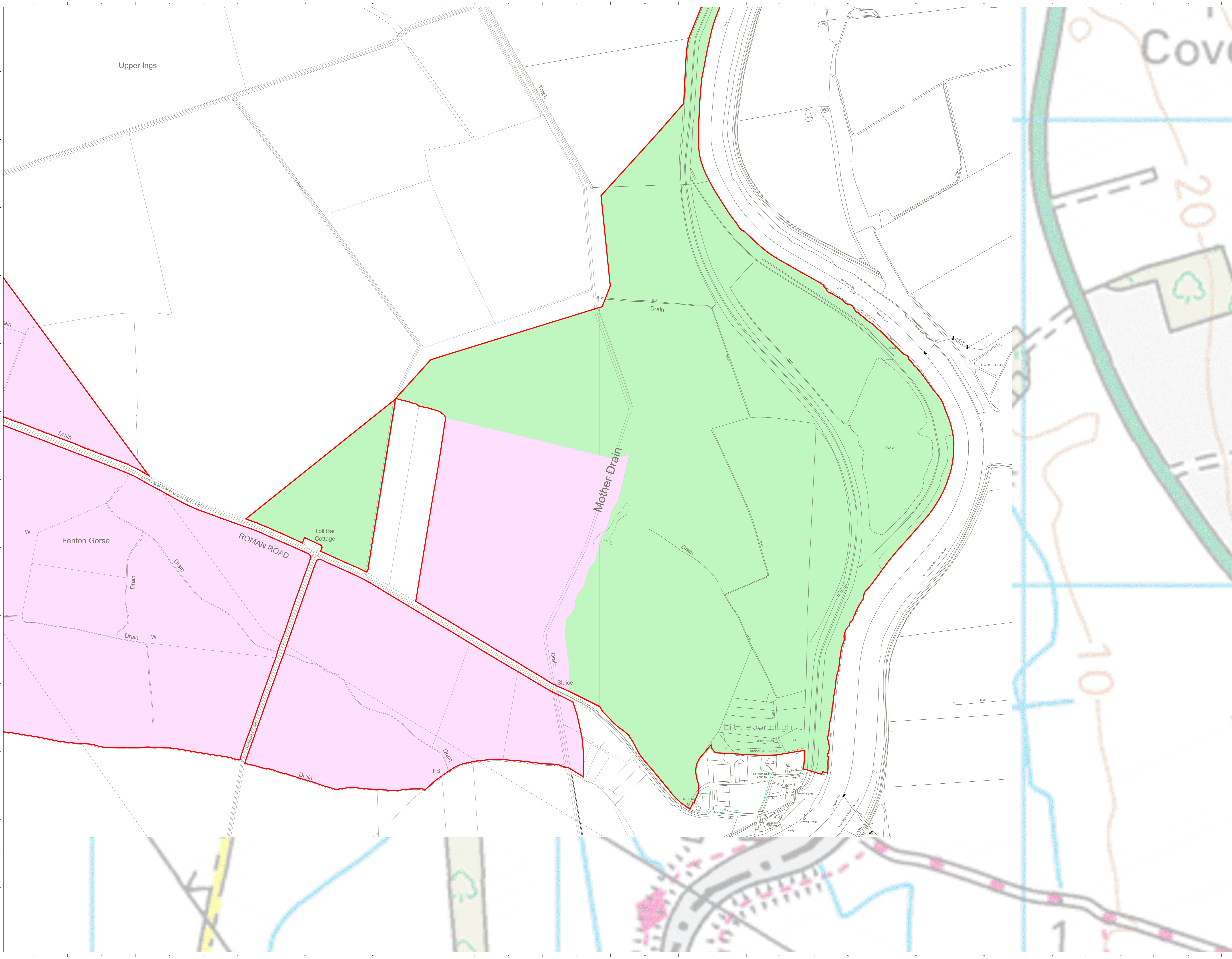

REV	NO	DATE	BY	CHKD	APPD	REVISION NOTES
1	1	2024/06/18				

PURPOSE	PRELIMINARY	COORDINATES	OSGB 1936
SCALE	1:2,500 @ AD	DATUM	N/A
LAYOUT DWG	N/A	LAYOUT NO.	N/A
PROJECT TITLE	STEEPLE RENEWABLES PROJECT		

DRAWING TITLE  
**FIGURE 1.2**  
**INDICATIVE PARAMETERS PLAN**  
APFP REGULATION 5(2)(A)

RES DRAWING NUMBER  
**04954-RES-LAY-DR-LE-018**

THIS DRAWING IS THE PROPERTY OF RESOURCES ENERGY CONSULTANTS AND NO REPRODUCTION MAY BE MADE IN WHOLE OR IN PART WITHOUT PERMISSION

